

SUN SYNK

DATA LOGGER



USER GUIDE

Global Tech China Ltd, 3 Floor, Wai Yip Industrial Building.
171 Wai Yip Street, Kwun Tong, Kowloon, Hong Kong.
Tel: +852 2884 4318 Fax: +8522884 4816
www.sunsynk.com / sales@globaltech-china.com
www.globaltechhk.com

Version 4.0 (07/27/2021)

**UK
CA**

INDEX

<u>1. INSTALLATION</u>	3
1.1. DATA LOGGER INSTALLATION	3
1.2. CONNECTING TO WI-FI	4
1.3. NETWORK CABLE	6
<u>2. ACCOUNT MANAGEMENT</u>	7
2.1. REGISTRATION	7
2.2. REQUESTING USER LEVEL ACCESS CHANGE	8
2.3. FORGOT PASSWORD	8
<u>3. PLANT MANAGEMENT</u>	9
3.1. CREATING A PLANT	9
3.2. ADDING A DEVICE	12
3.3. EDITING A PLANT	13
3.4. TRANSFERING A PLANT	14
3.5. DELETING A PLANT	16
3.6. PLANT MAP	17
3.7. INVERTER STATISTICS	18
3.8. PLANT OVERVIEW	19
<u>4. EQUIPMENT</u>	23
4.1. GATEWAY MANAGEMENT	23
4.2. GATEWAY DISTRIBUTION	24
4.3. INVERTER MANAGEMENT	26
4.4. CHANGE INVERTER SETTINGS	27
4.5. INVERTER FIRMWARE MANAGEMENT	28
4.6. INVERTER FIRMWARE MANAGEMENT	30
<u>5. ENTERPRISE MANAGEMENT</u>	31
5.1. COMPANY INFORMATION	31
5.2. ROLE MANAGEMENT	32
5.3. STAFF MANAGEMENT	33
5.4. SETTING / CHANGING CUSTOMER PERMISSIONS	34
5.4.1 CREATING USER PERMISSIONS	34
5.4.2 ASSIGNING CUSTOMER PERMISSIONS	36
5.5. SHARING A PLANT	37

1. INSTALLATION

1.1. DATA LOGGER INSTALLATION

Insert the Data Logger into the DB9 interface of the inverter, as shown in the following figure.

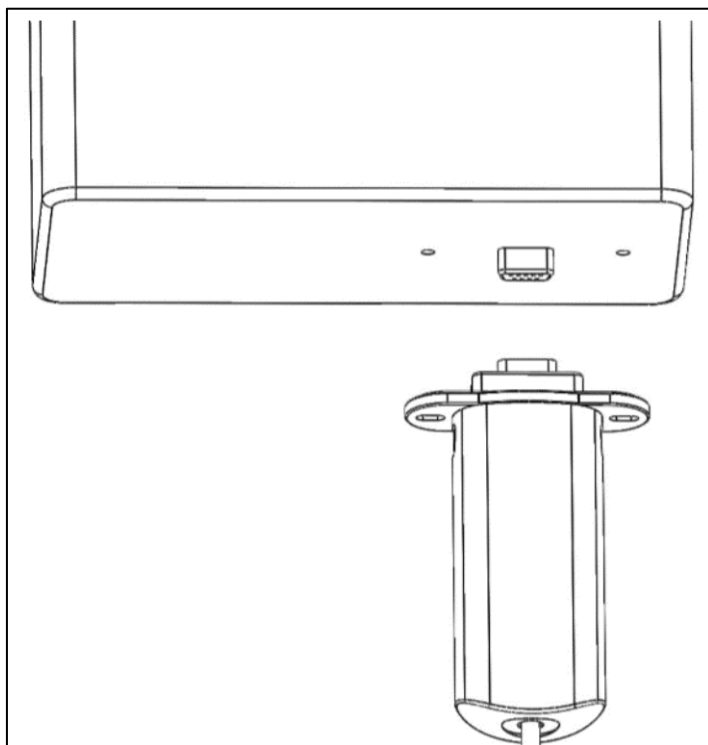

Insert the two screws that come with the Data Logger through the holes, and then tighten them with a Phillips screwdriver, as shown in the figure below.

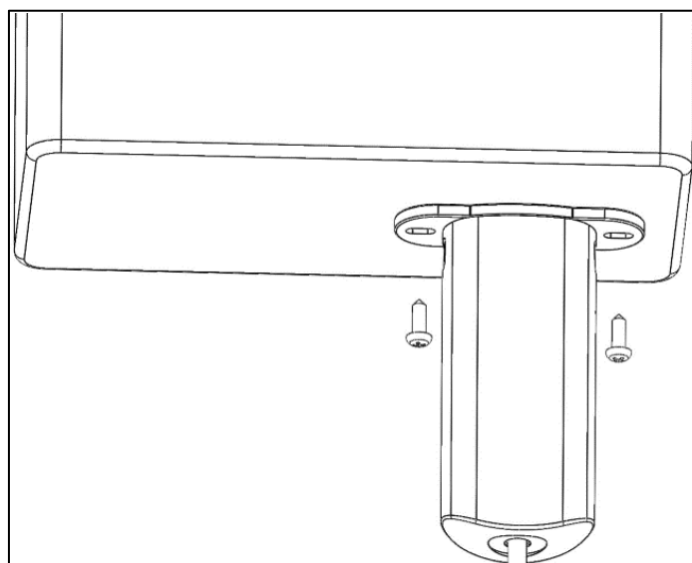

1.2. CONNECTING TO WI-FI

To connect the data logger to the Wi-Fi you need to go to the Wi-Fi setting on your device and search for it. You will see an available connection with the SSID 'EAP-*****' ('*****' are the last 5 digits of the serial number on the data logger).

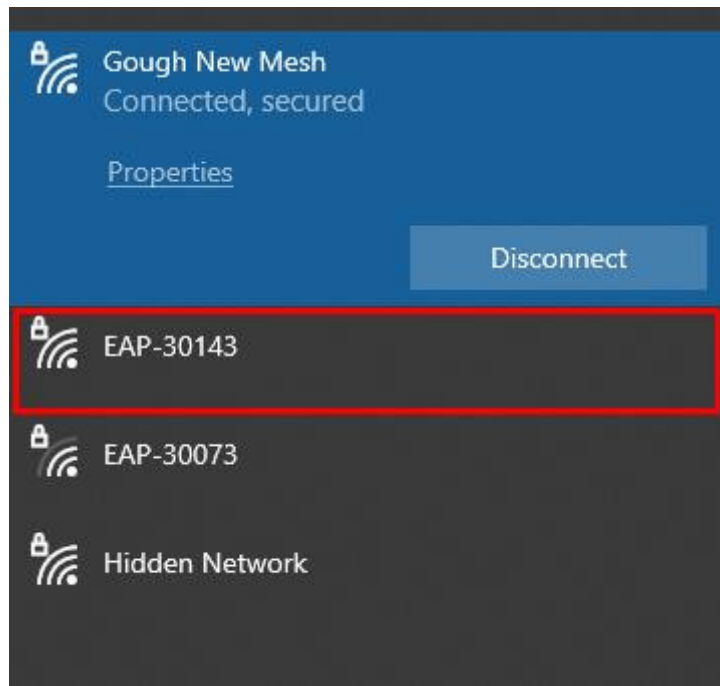

1) Select the correct connection and then enter the password **12345678**.

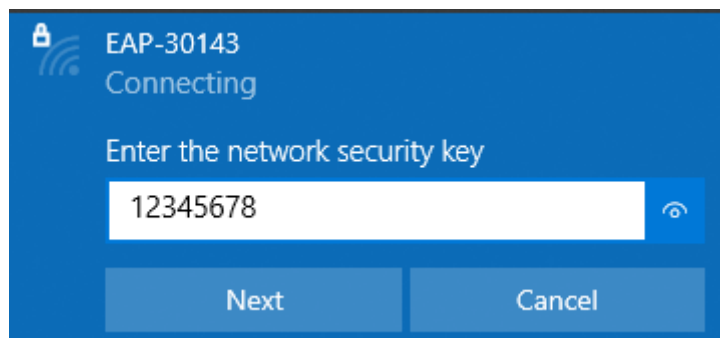

2) Once you have connected to the EAP connection, you need to connect it to your own Wi-Fi. To do this, open the Internet browser and search the IP address **10.10.10.1**.

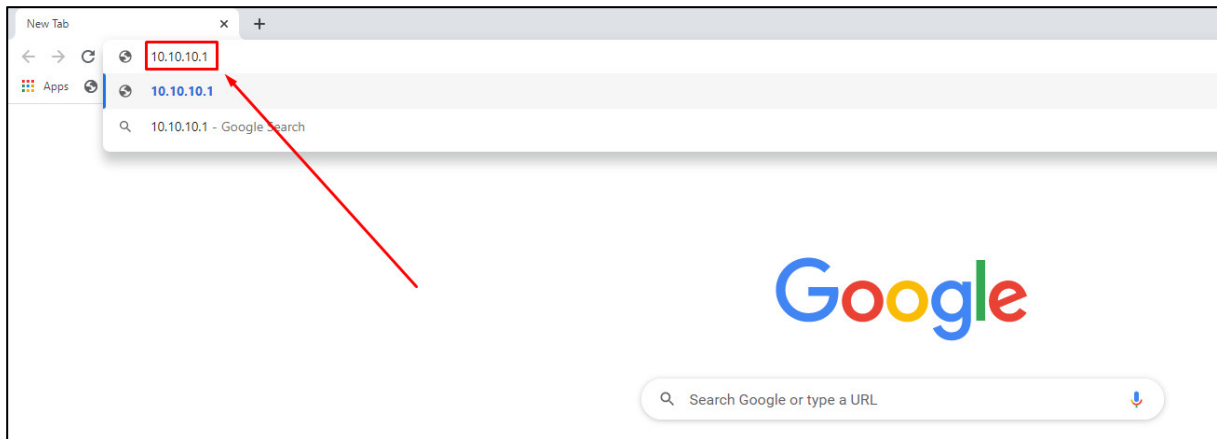

3) Once connected, click 'Scan' to search the Wi-Fi List and you should then see your Wi-Fi connection.

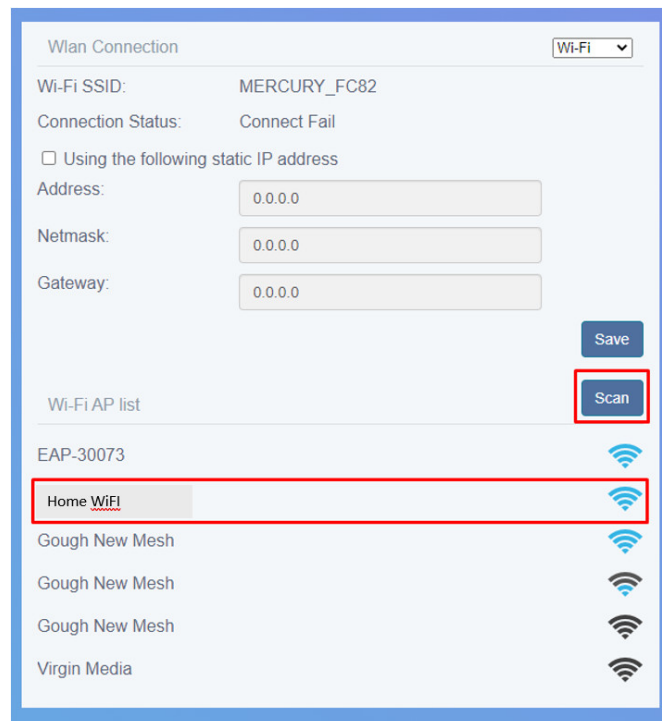

- 4) Select your Internet / Wi-Fi connection, enter your password, and click 'Connect'.
- 5) Once your data logger is connected to your Wi-Fi, you can then disconnect from the data loggers EAP connection and connect back to your usual wi-fi connection.

1.3. NETWORK CABLE

Use a flat-blade screwdriver to press the buckles on the left and right sides of the shell, as shown in the following figure. Then extract the DB9 interface part manually.

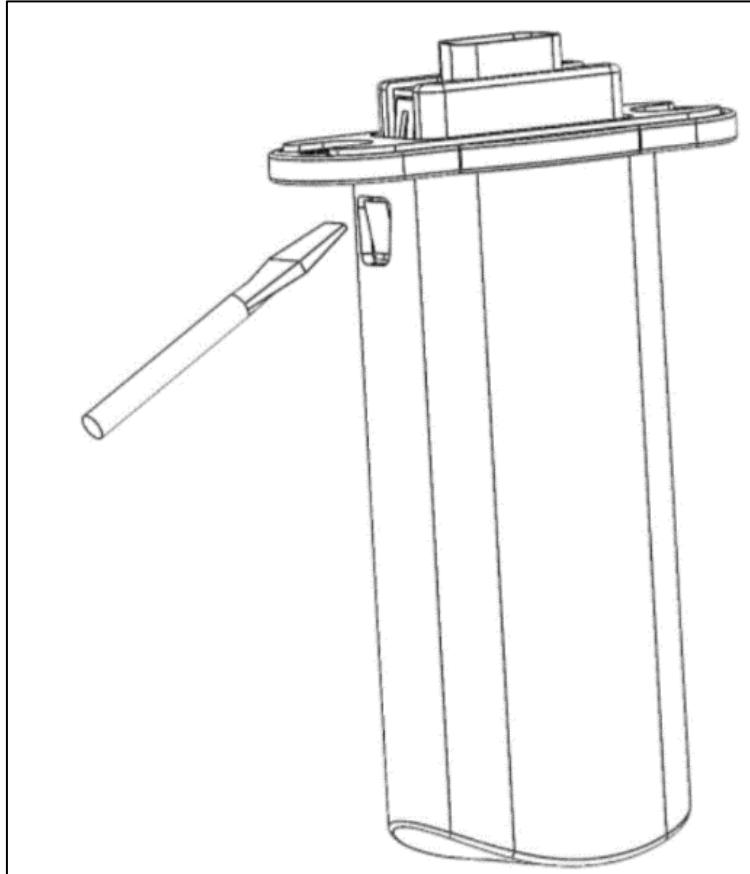

Pass the network cable through its specific hole at the bottom of the shell. Then, insert the RJ45 plug into the RJ45 socket, and place the sealing plug with the hole on the network cable, as shown in the figure below.

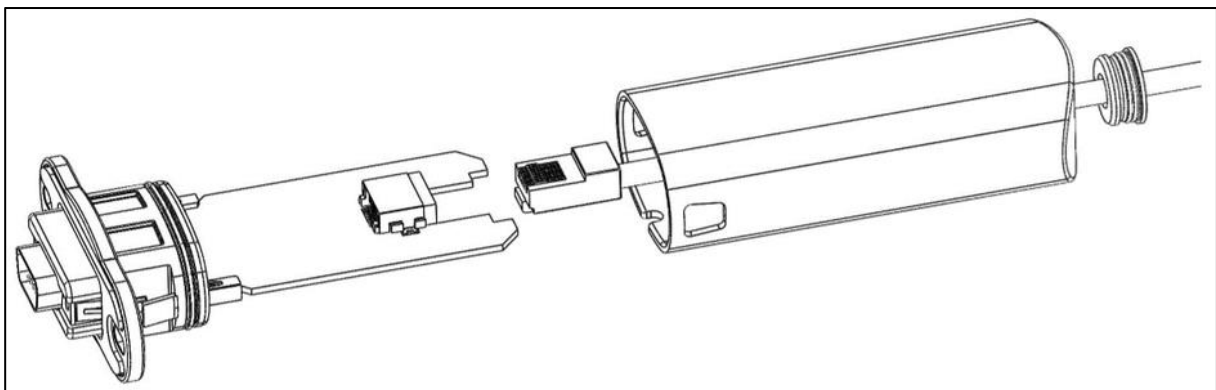

2. ACCOUNT MANAGEMENT

2.1. REGISTRATION

Enter <http://sunsynk.net> in your browser to access the web version of the management tool. Then, click 'Sign Up' on the Login page to access the Registration page.

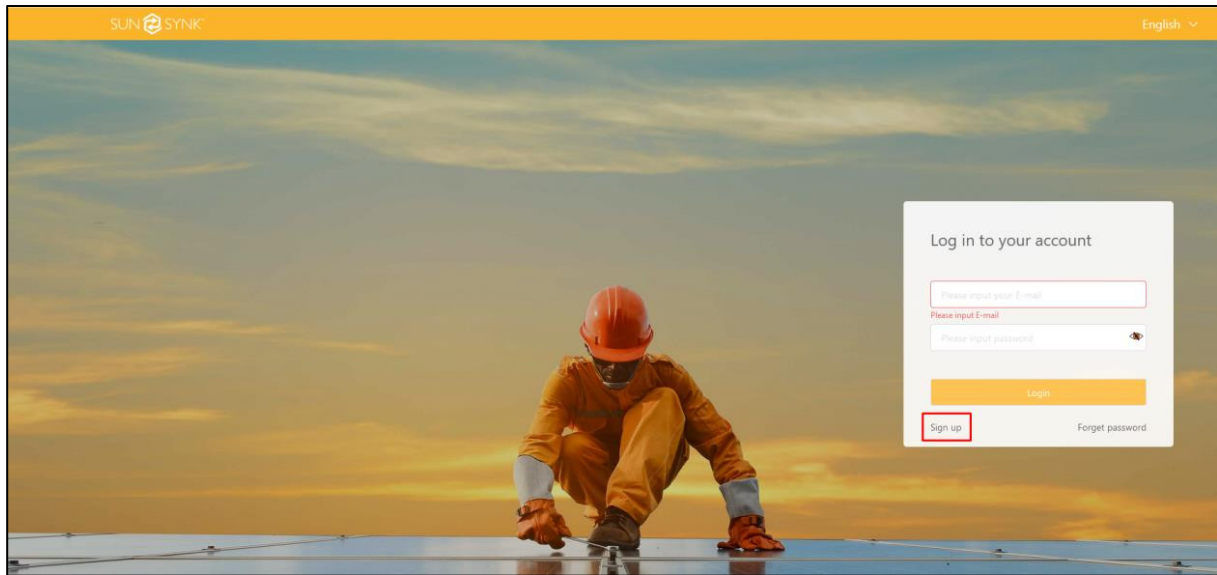

Enter a valid phone number or e-mail address to receive the verification code. After completing the registration information, enter a password, check the box in the user agreement to indicate that you have read and agree to the agreement, then click 'Agree and register'.

Register

 I have read and agreed to the Terms & Privacy
Policy [《User Agreement》](#)

Already have an account? [Login](#)

2.2. REQUESTING USER LEVEL ACCESS CHANGE

If you are an installer and have registered an account on the Sunsynk Logger platform, you may have the default basic user account with limited permissions. Therefore, to request a different user level so that you can change parameters, remotely upgrade the inverter, in addition to other functions, please visit <https://www.sunsynk.org/user-level-access-change> and fill in the form.

2.3. FORGOT PASSWORD

Click 'Forget password' at lower right corner on the Login page to access the Reset Password page.

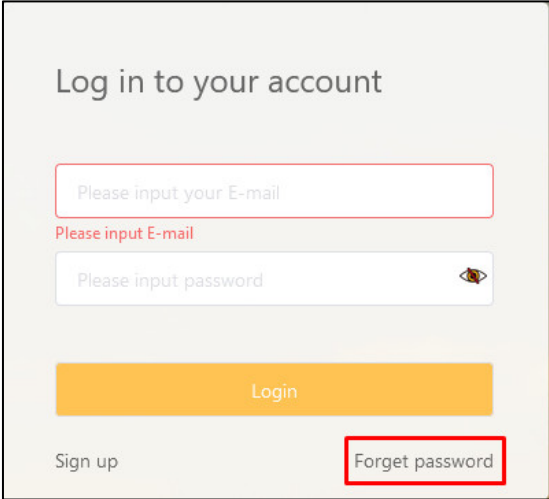

Log in to your account

Please input your E-mail

Please input password

Login

Sign up

Forget password

Enter your e-mail address to receive the verification code. Then, enter the verification code, choose your new password, and click 'Confirm' to set the new password.

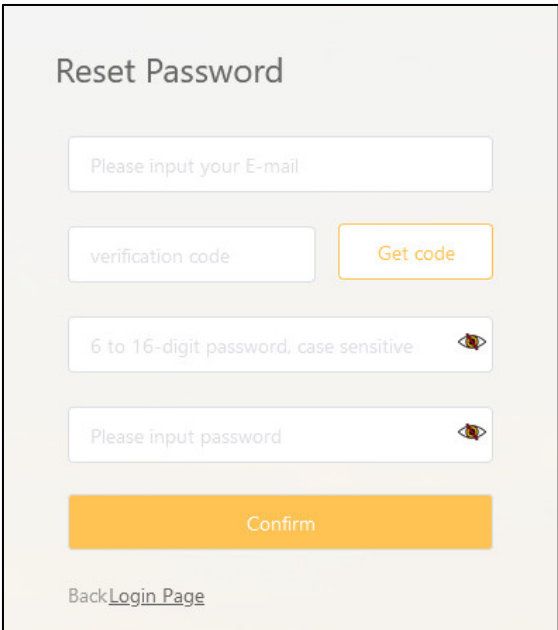

Reset Password

Please input your E-mail

verification code

Get code

6 to 16-digit password, case sensitive

Please input password

Confirm

Back Login Page

3. PLANT MANAGEMENT

3.1. CREATING A PLANT

In the menu, first click 'My Plant', then 'Plant List'.

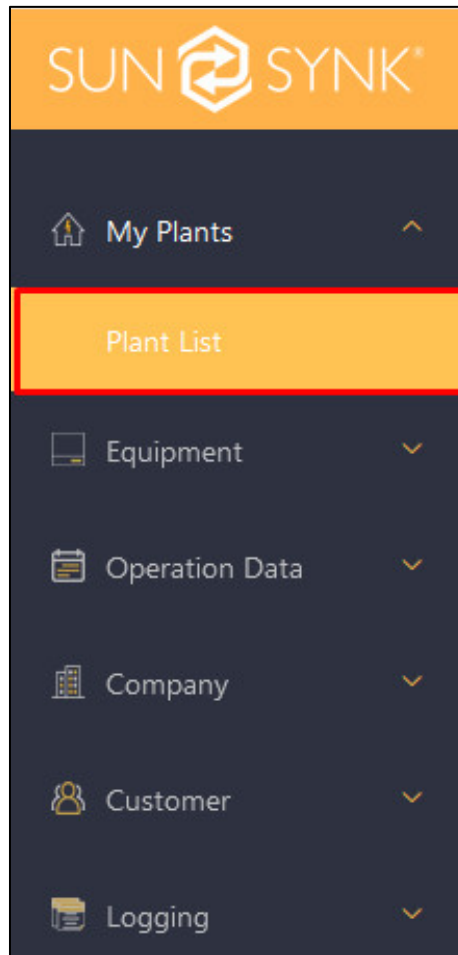

1) To create a new plant, click 'Create a Plant' on the right corner of the page.

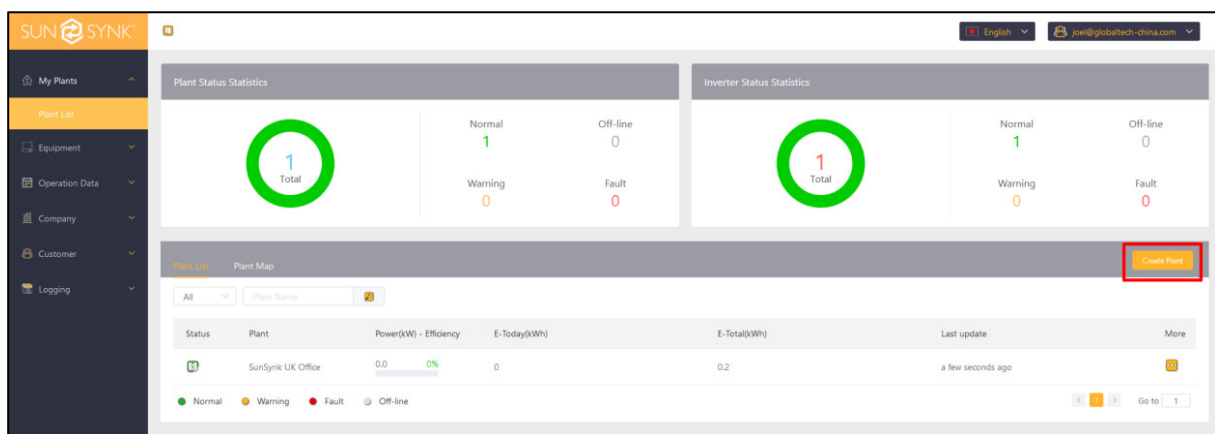

2) Enter the Serial Number (SN) and KEY on the Data Logger label, then click the 'Next'.

The screenshot shows the 'Create Plant' interface with a progress bar indicating the 'Plant Info.' step. Below the progress bar, there are two input fields: '* SN' and '* Key', both with 'Please input' placeholder text. To the right of these fields is a QR code and a small image of a data logger label with the following text: 'Wi-Fi Stick', 'PIN: EGEG-0009-A45', 'SN: E4001-0001', 'KEY: QDR8 ***** WSNV BYAY', and 'Changda E-LINKER Information Technology Co., Ltd.'. Below the input fields are 'Cancel' and 'Next' buttons.

3) Enter the total capacity in 'Capacity' select the correct type in 'Plant Type', the information displayed on the page will be different if choose different types of plants. To ensure the accuracy of the plant statistics, please fill in the information on the page correctly.

The screenshot shows the 'Create Plant' interface with the following fields: '* Plant Name' (Please input), '* Capacity' (Please input kWp), '* Commissioning Date' (2021-04-28), 'Plant Type' (Grid-Tied selected, Energy Storage (AC Coupling), Energy Storage (DC Coupling)), and 'Installer' (Please input). To the right is a dashed box for an image upload with a plus icon and the text: 'Upload picture The file format must be JPG, JPEG, PNG, and size can not exceed 10MB'.

4) You can enter the installation address of the plant in the address input box on the map to locate the specific installation location or you can use the map to select the correct installation location.

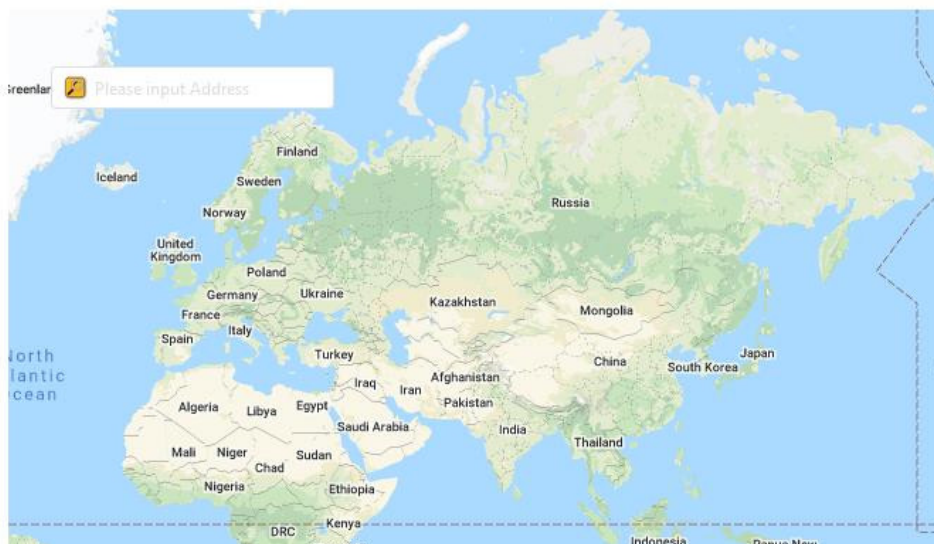

5) Also, please confirm if the time zone of the plant is correct. If it is not, please change it. Finally, click 'Next'.

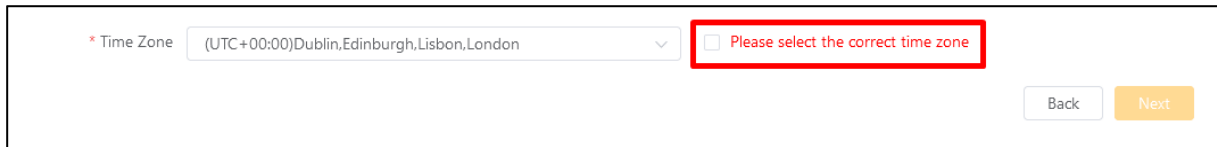

* Time Zone (UTC+00:00)Dublin,Edinburgh,Lisbon,London

Please select the correct time zone

Back Next

6) Select your currency, your total investment, and your preferred Valuation Method. **Note:** The Live Price option is only currently available for UK customers.

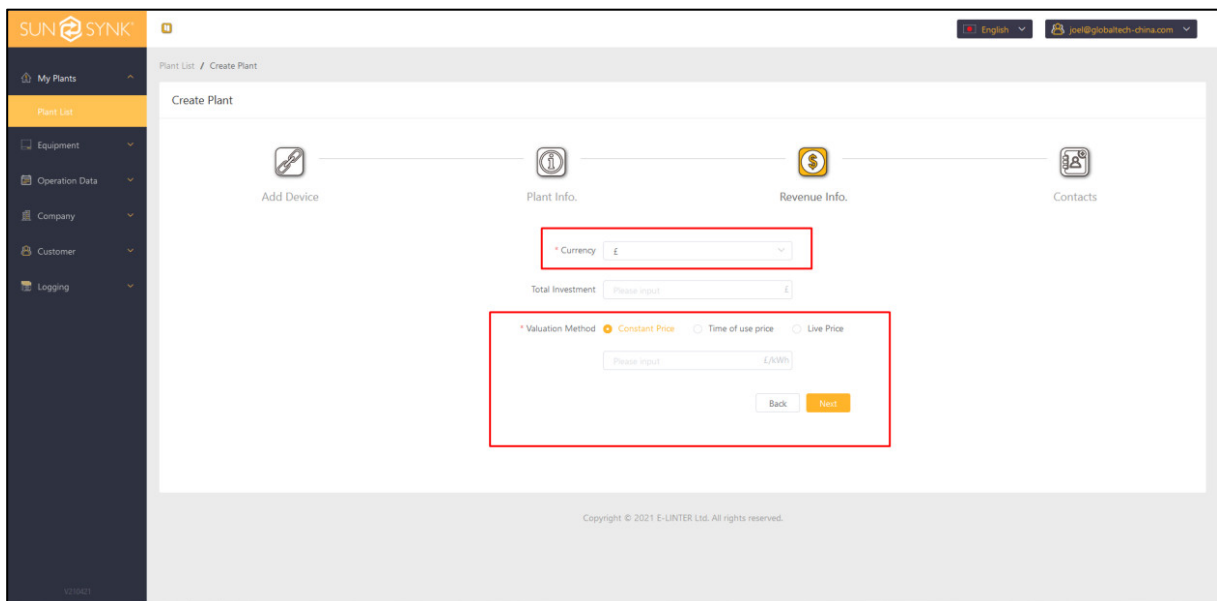

SUN SYNK

Plant List / Create Plant

Create Plant

Add Device Plant Info. Revenue Info. Contacts

* Currency £

Total Investment Please input

* Valuation Method Constant Price Time of use price Live Price

Please input £/kWh

Back Next

Copyright © 2021 E-LINTER Ltd. All rights reserved.

7) Enter the name of the user who is going to manage the system, their phone number, and e-mail.

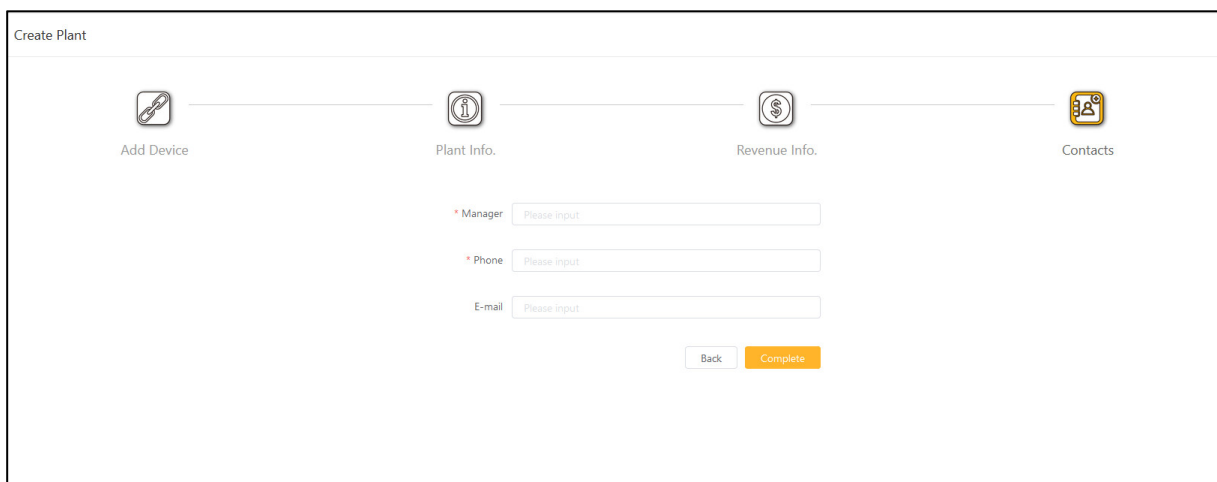

Create Plant

Add Device Plant Info. Revenue Info. Contacts

* Manager Please input

* Phone Please input

E-mail Please input

Back Complete

3.2. ADDING A DEVICE

In the menu, first click 'My Plant', then 'Plant List'.

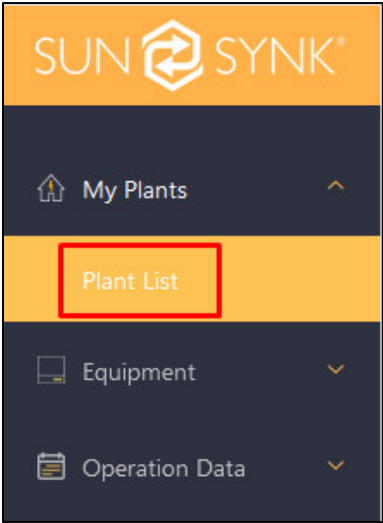

1) Select the plant that need to add equipment from the 'Plant List'.

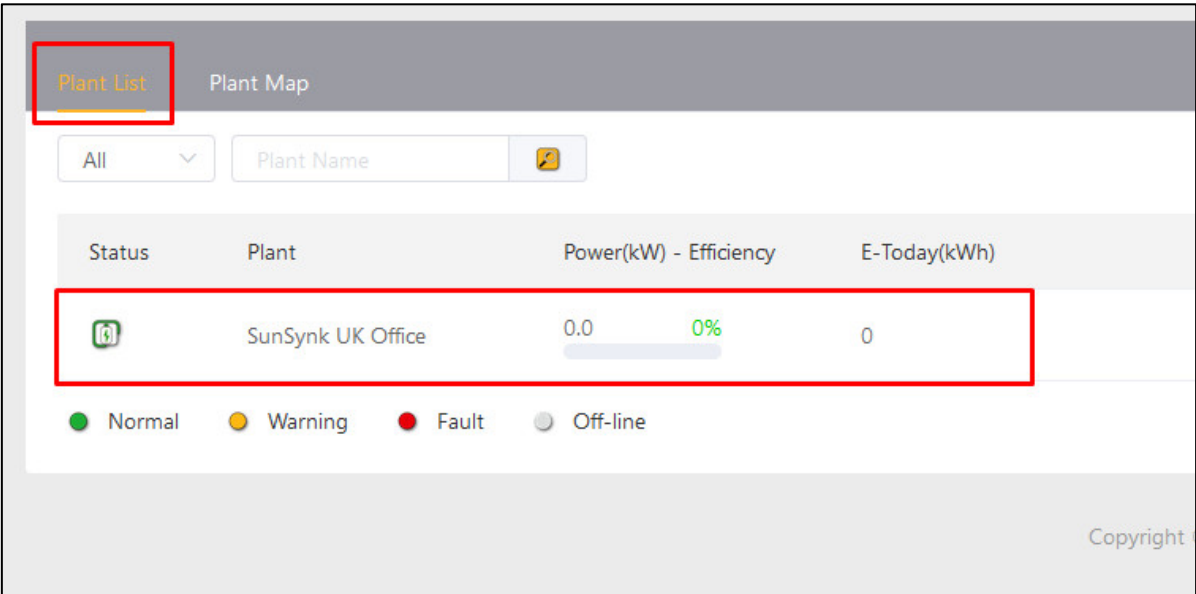

2) Click the 'More (...)' button and Select 'Add Gateway'.



3) Input the serial number SN and Key of the Data Logger to be connected, and finally 'Confirm'.



The image shows a 'Message' dialog box with a close button (X) in the top right corner. It contains two input fields: one for '* SN' and one for '* Key', both with the placeholder text 'Please input'. At the bottom right, there are two buttons: 'Cancel' and 'Confirm'.

3.3. EDITING A PLANT

In the menu, first click 'My Plant', then 'Plant List'.

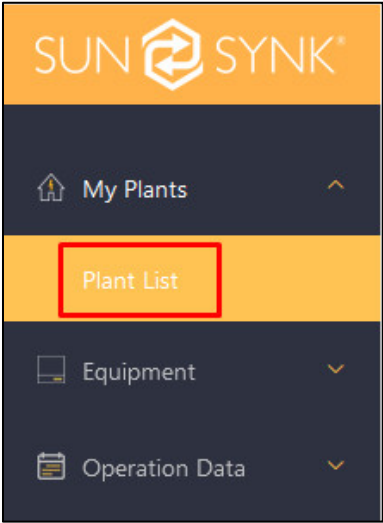

1) Select the plant that need to be edited from the 'Plant List'.

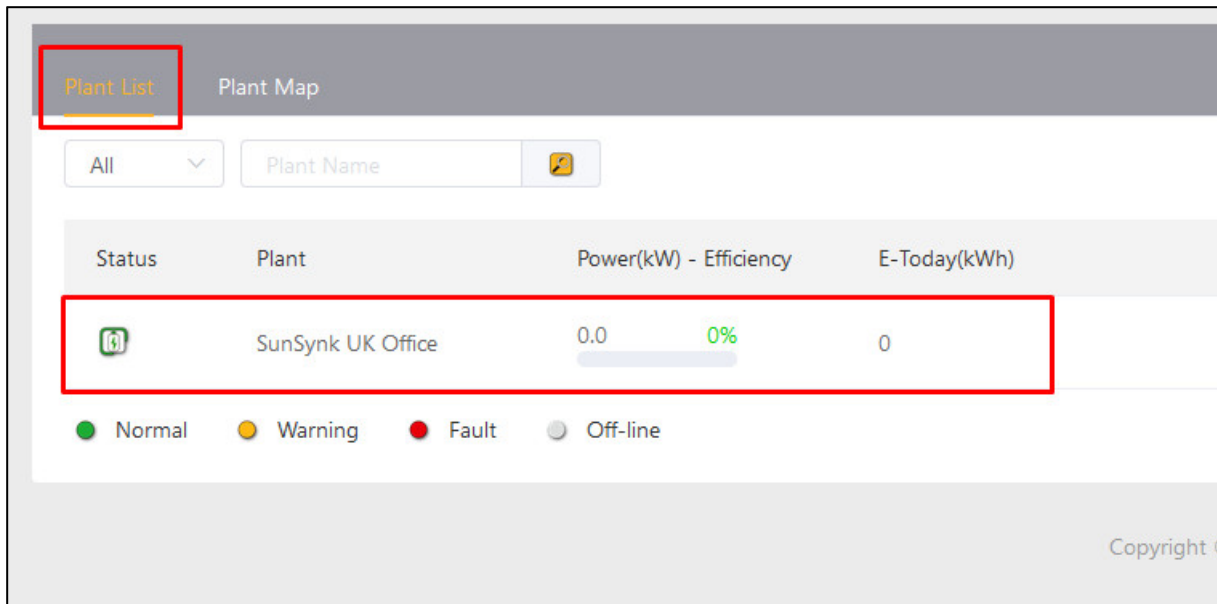

2) Click the 'More (...)' button and select 'Edit' to enter the Edit Plant page in order to make the changes to the plant.

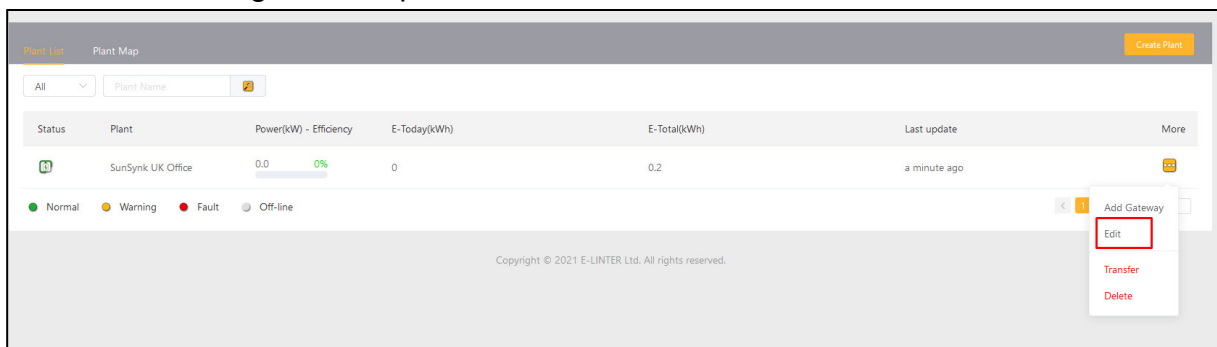

3.4. TRANSFERRING A PLANT

NOTICE

When transferring a plant to another user this will remove the ownership from you and you will no longer be able to access that plant.

In the menu, first click 'My Plant', then 'Plant List'.

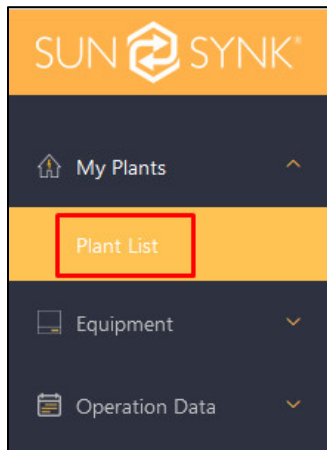

1) Select the plant that need to be edited from the 'Plant List'.

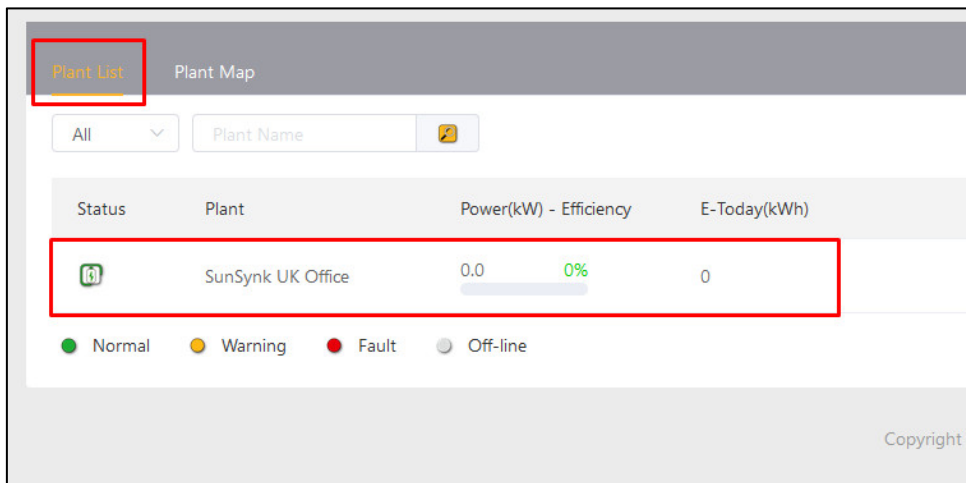

2) Click the 'More (...)' button and select 'Transfer' to enter the Transfer Plant page in order to make the changes to the plant.



3) Enter the user's account in the pop-up window to complete the transfer of the plant.

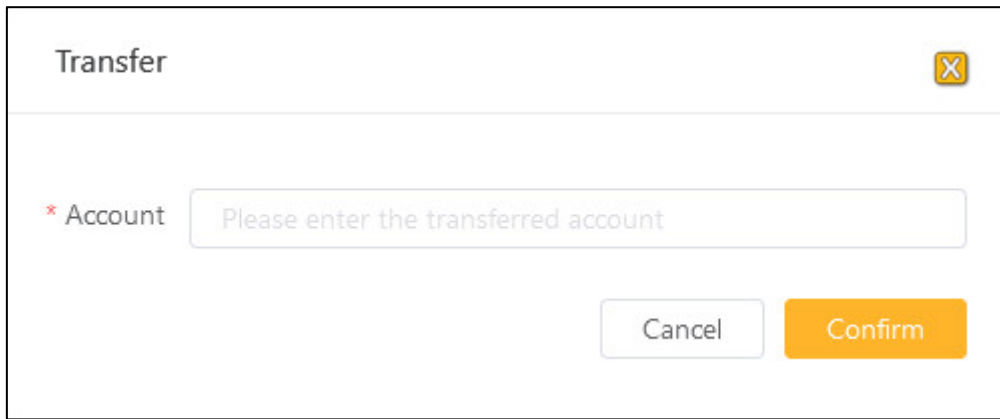

A dialog box titled "Transfer" with a close button (X) in the top right corner. Below the title bar, there is a label "* Account" followed by a text input field containing the placeholder text "Please enter the transferred account". At the bottom right of the dialog, there are two buttons: "Cancel" and "Confirm".

3.5. DELETING A PLANT

In the menu, first click 'My Plant', then 'Plant List'.

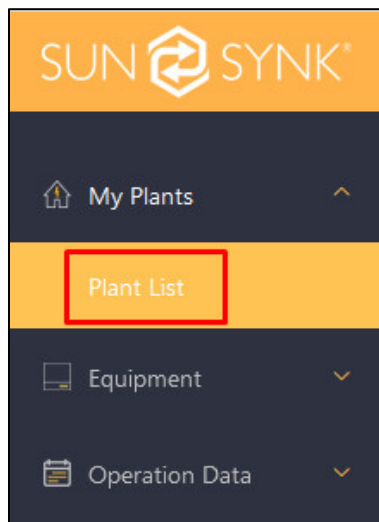

1) Select the plant that need to be deleted from the 'Plant List'.

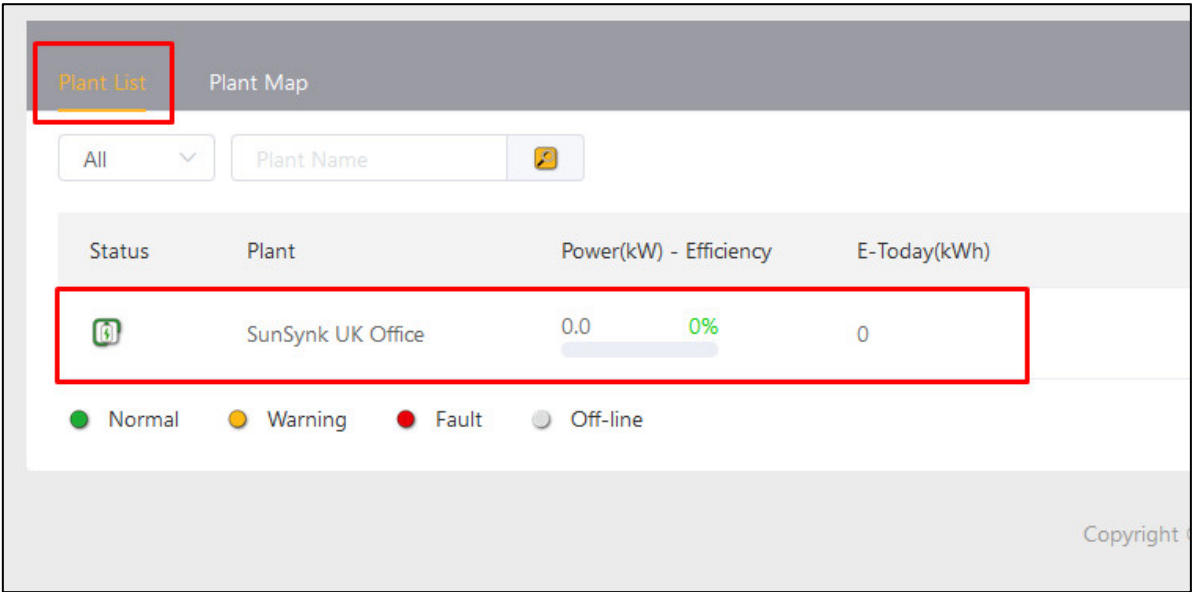

2) Click the 'More (...)' button and select 'Transfer' to enter the Transfer Plant page in order to make the changes to the plant.



3.6. PLANT MAP

In the menu, first click 'My Plant', then 'Plant List'.

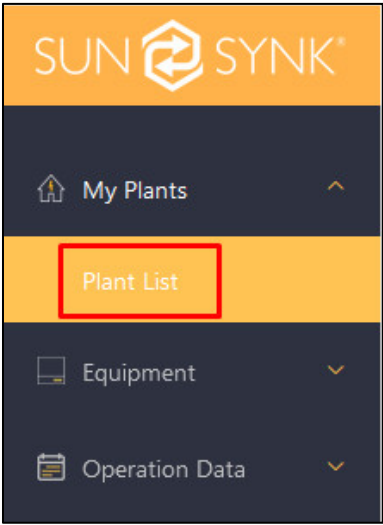

1) Click 'Plant Map'.

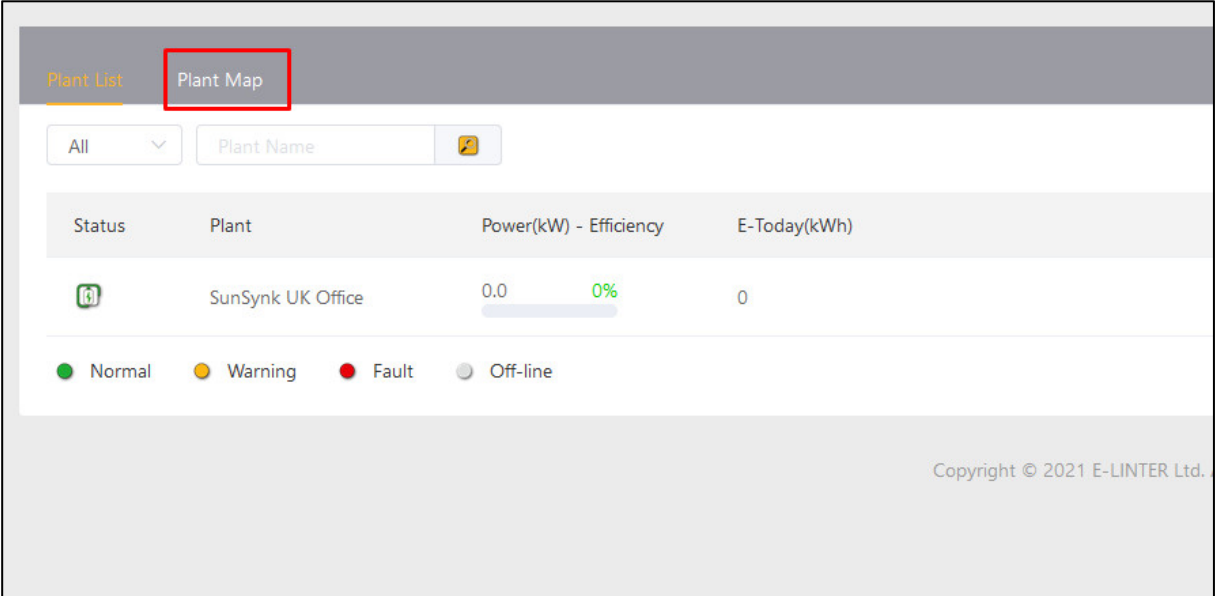

A map with the listed plants will be displayed.

3.7. INVERTER STATISTICS

Click in the menu: 'My Plant' → 'Plant List', you can intuitively know the statistical quantities of status of all inverters under this account in [Inverter Status Statistics].

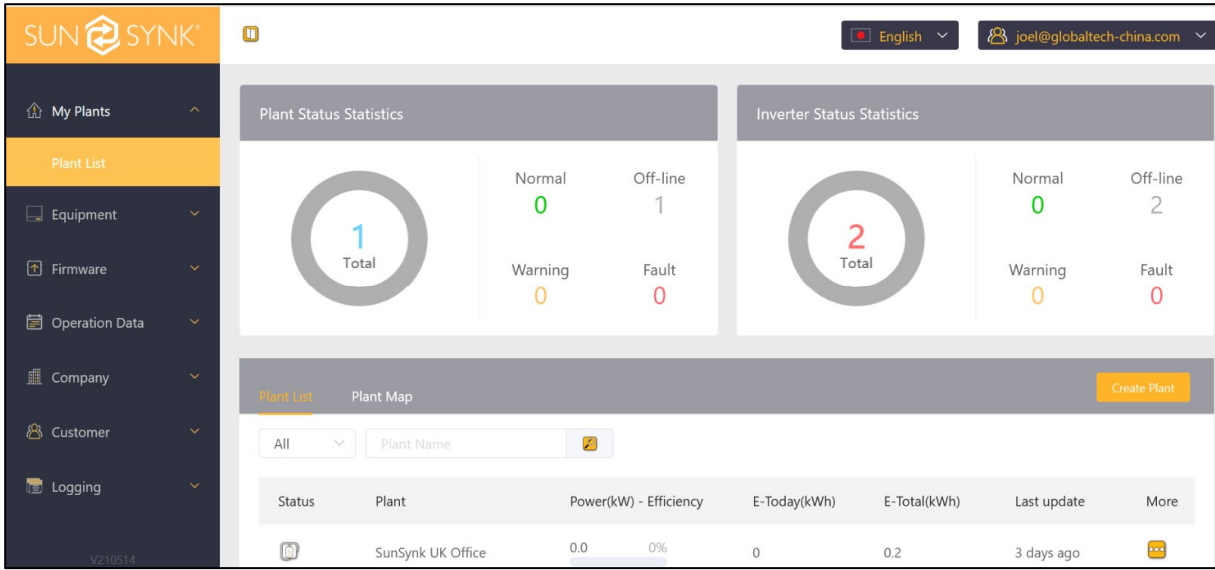

Click the < or > icon to view the abnormal information of the inverter in the last hour, as shown in the following figure.



3.8. PLANT OVERVIEW

In the menu, first click 'My Plant', then 'Plant List'.

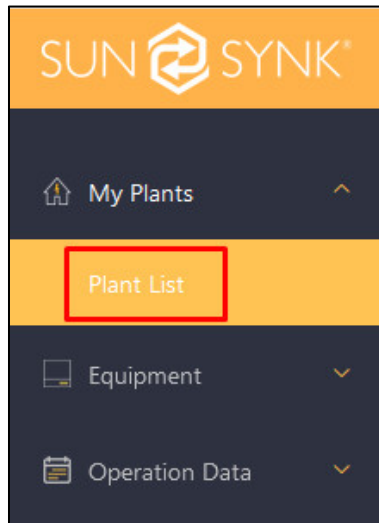

1) Select plant list 'Plant List' and click the corresponding plant name to enter the plant Overview page.

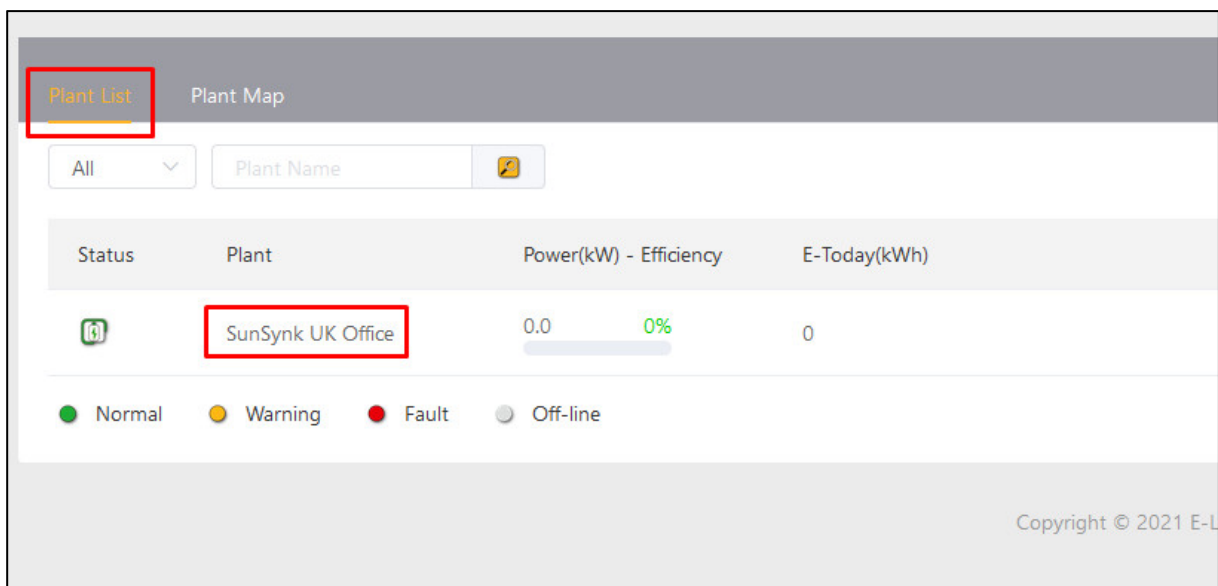

2) In the plant overview page, you can view the status of the plant, weather information, energy flow diagram, inverter status, abnormality in the past hour, power generator chart and other information.

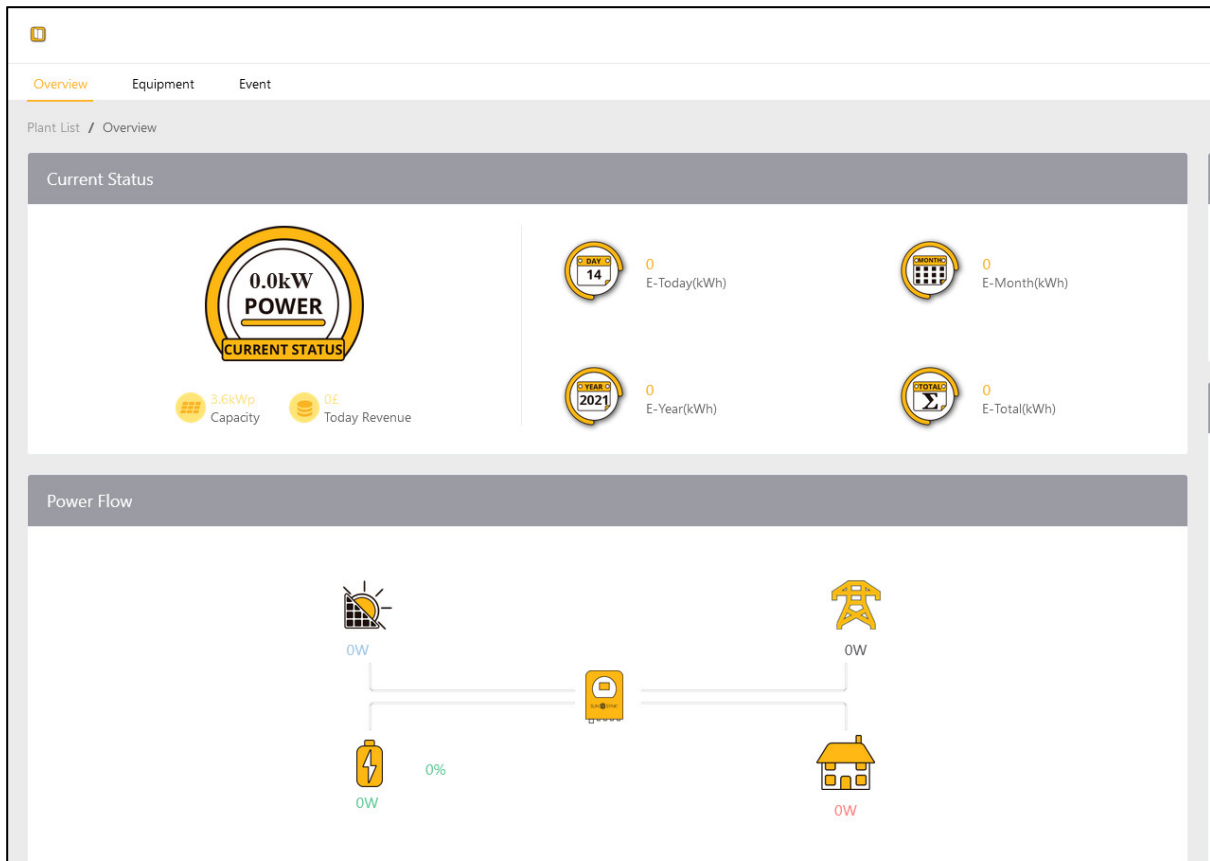

3) Click 'Equipment' in the Overview page to enter the Equipment page. Here you can view all the equipment in the plant, the corresponding operational data charts, remote upgrades, parameter Settings, and other operations.

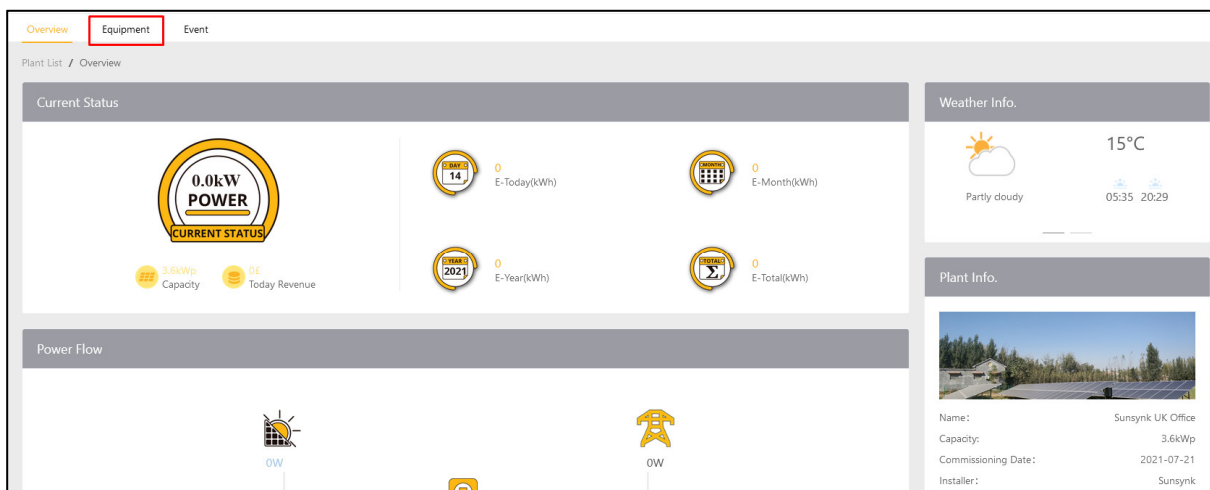

4) In the Equipment page, click the more button '(...)' in the upper right corner to set an alias for the device, perform remote upgrade, and change inverter settings / parameters, as shown in the figure below.

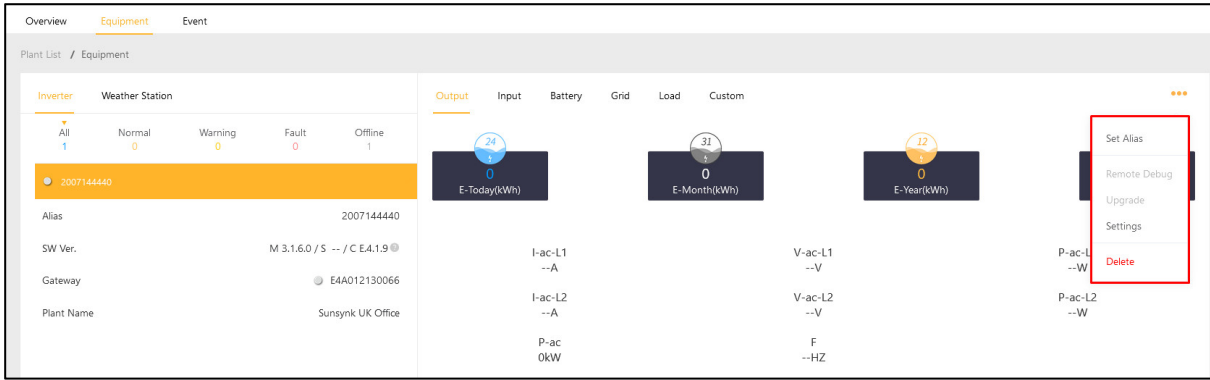

5) Click 'Event' menu in the power plant Overview page to switch to the Event page.

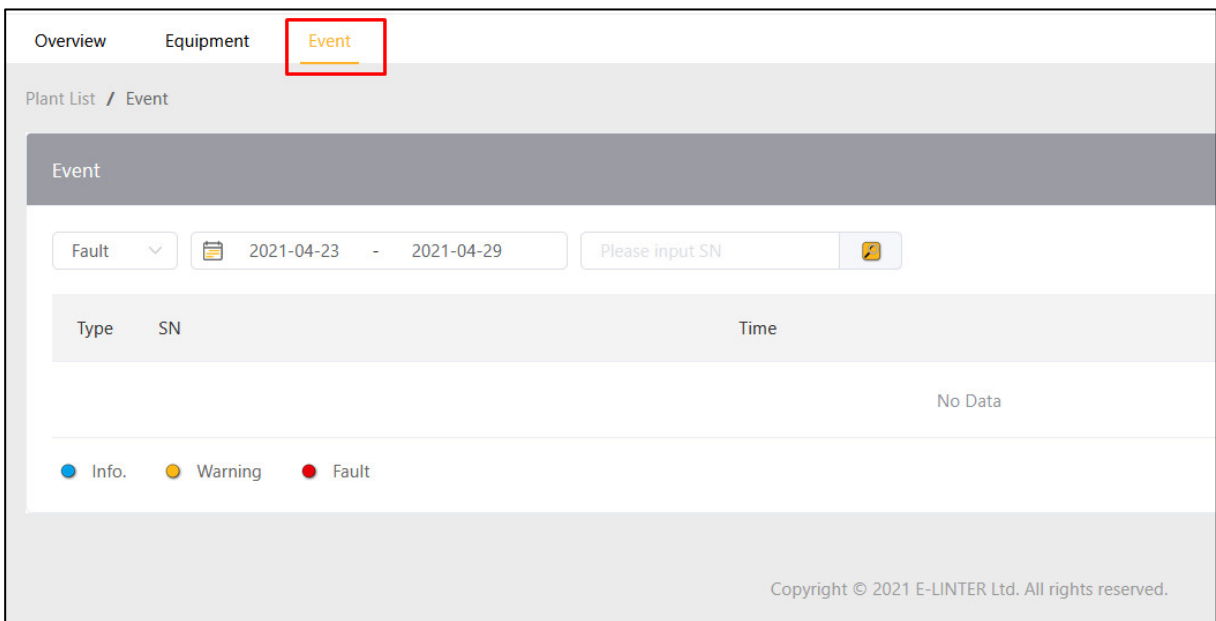

Here you can view the current plants abnormal information, as shown in the figure below.

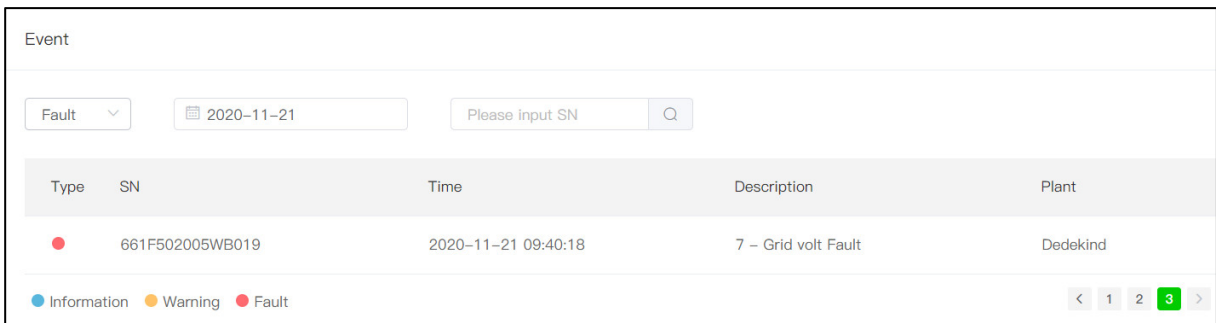

4. EQUIPMENT

4.1. GATEWAY MANAGEMENT

In the menu, click 'Equipment' → 'Gateway', to enter the Gateway List page.

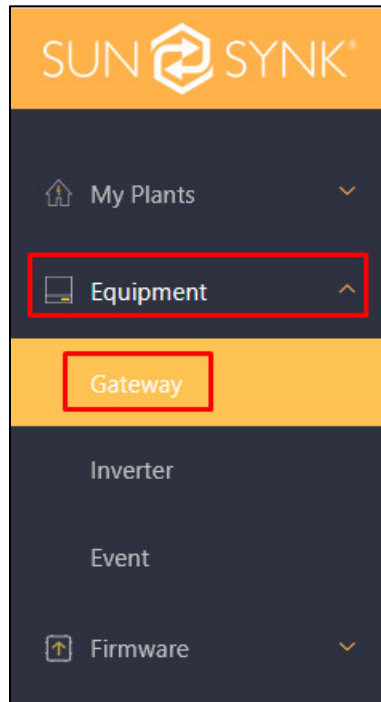

In the Gateway List page, click on the 'SN' of a gateway to view the detailed information of the Data Logger.

<input type="checkbox"/>	Status	SN	Key
<input type="checkbox"/>	●	E470119C3186	EFM*****7AW
<input type="checkbox"/>	●	E41012080003	YS9*****UHU
<input type="checkbox"/>	●	E41012080002	KLS*****QAS

If you need to remove the gateway from a power station, you need to unbind the gateway from the plant where it is located. The specific operation is as follows:

- 1) Select the gateway to be unbound on the Gateway List page.
- 2) Click the more button '(...)' and select 'Unbind' in the popup menu.
- 3) Follow the prompts to complete the unbind operation, as shown in the following figure.

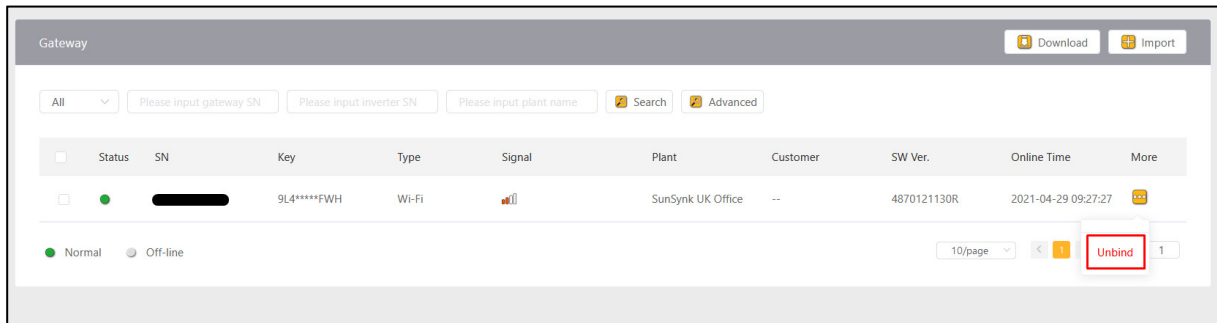

4.2. GATEWAY DISTRIBUTION

In the menu, click 'Equipment' → 'Gateway', enter the Gateway Management page and click the 'Import' button.

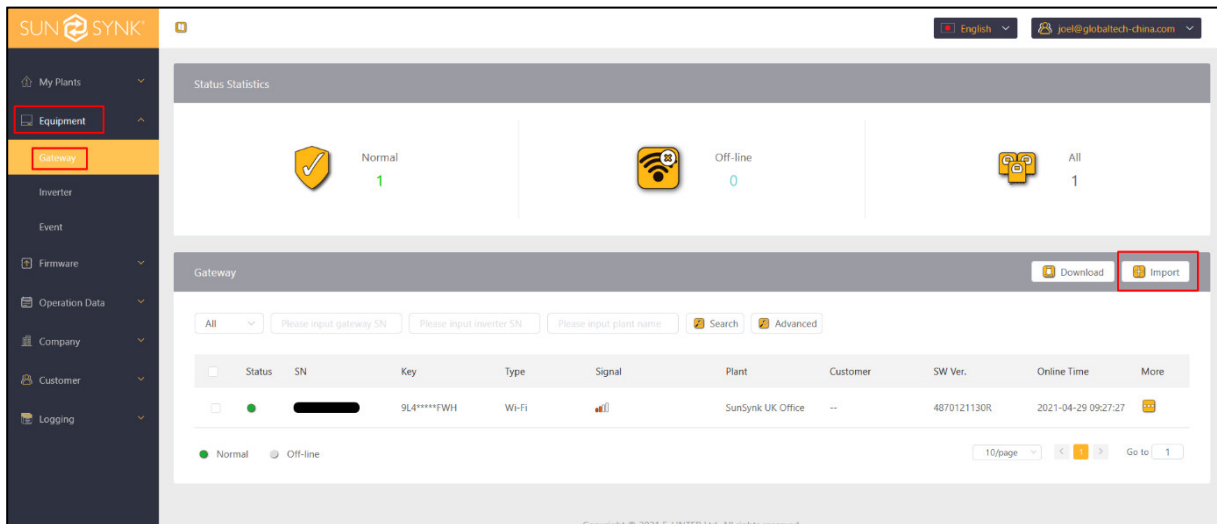

- 1) Click 'Template', download the template for importing the gateway, fill in the SN and KEY for the gateway to be assigned to the template, and save it.

Import Gateway

[Back](#) [Add One](#)

Customer

i If the customer is not selected, the collector will be imported to the current user company by default.

[Select Files](#)

Only support .xls or .xlsx files

[Template](#) [Cancel](#) [Confirm](#)

2) Click the 'Select File' button to select the template file that has been written in the Data Logger information.

3) Select assigned/imported customers (Dealers/Distributors) and then confirm.

Import Gateway

[Back](#) [Add One](#)

Customer

i If the customer is not selected, the collector will be imported to the current user company by default.

[Select Files](#)

Only support .xls or .xlsx files

[Template](#) [Cancel](#) [Confirm](#)

4.3. INVERTER MANAGEMENT

In the menu, click 'Equipment' → 'Inverter' to enter the Inverter List page.

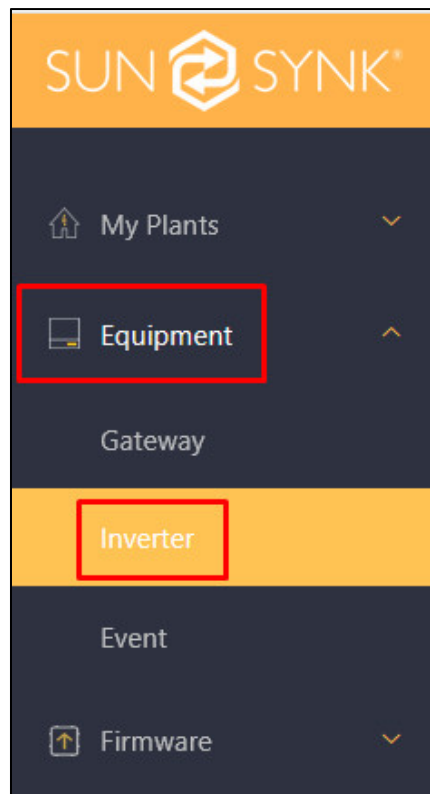

1) In the Inverter List page, click on the SN of an inverter to view the detailed information and operational data of the inverter.

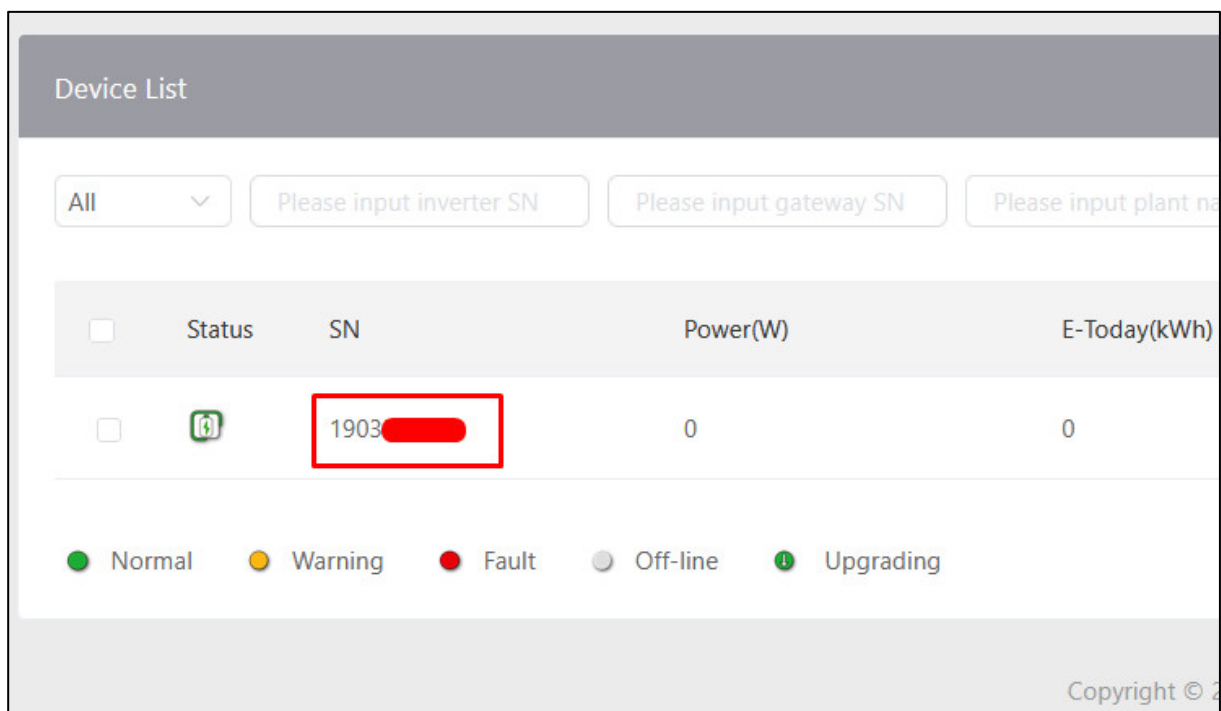

2) Click on the plant name to enter the plant of the inverter.

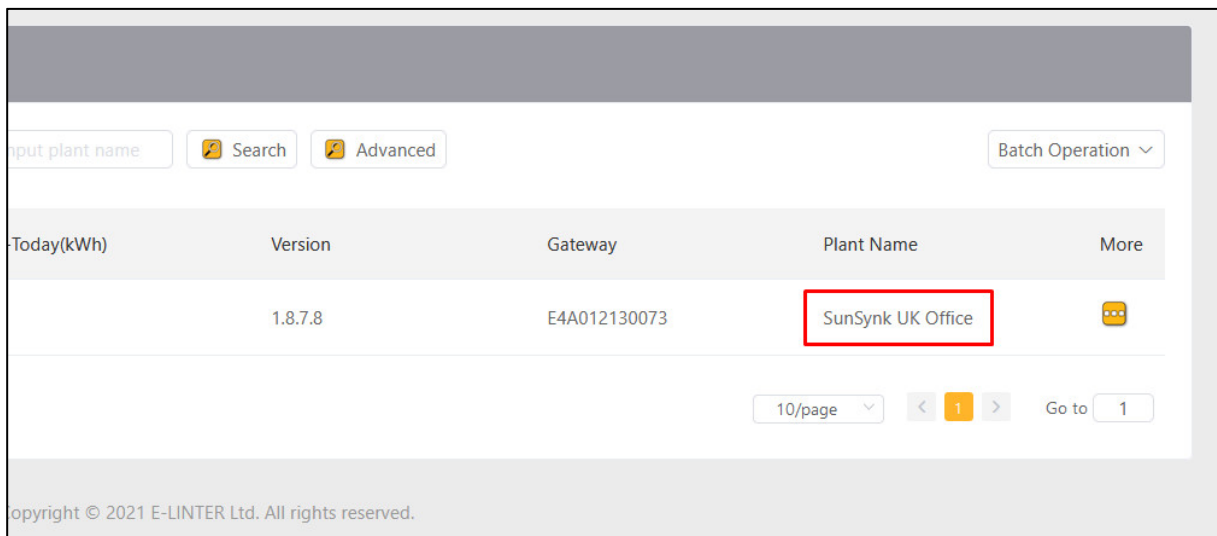

Today(kWh)	Version	Gateway	Plant Name	More
	1.8.7.8	E4A012130073	SunSynk UK Office	

10/page < 1 > Go to 1

copyright © 2021 E-LINTER Ltd. All rights reserved.

4.4. CHANGE INVERTER SETTINGS

In the menu, click 'Equipment' → 'Inverter' to enter the Inverter List page.

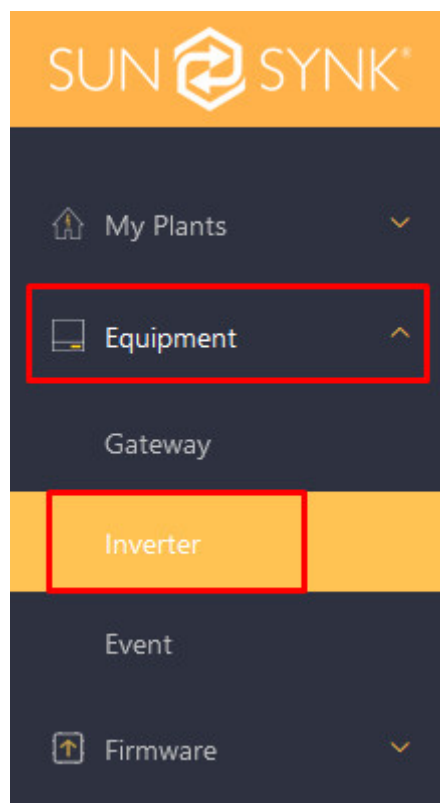

In the Inverter List click More '(...)', then select the Inverter you wish to edit the settings, and finally click 'Settings'.

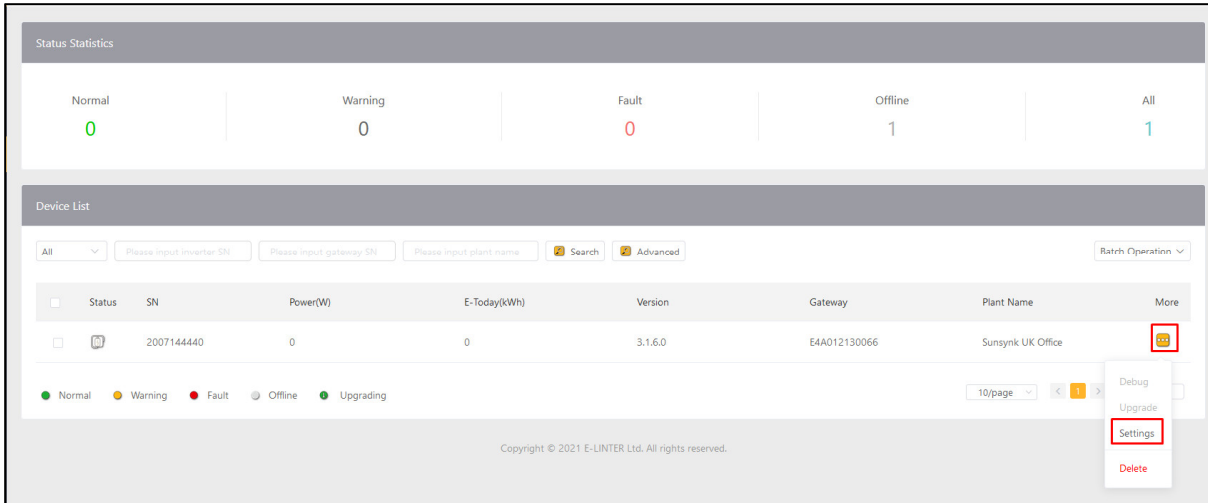

You will then have access to the settings for that inverter such as Battery Setting, Timer, Grid Setting, Aux Load Output, Basic Setting, Advanced Setting.

4.5. INVERTER FIRMWARE MANAGEMENT

In the menu, click 'Firmware → 'Inverter Firmware' to enter the Inverter Firmware page.

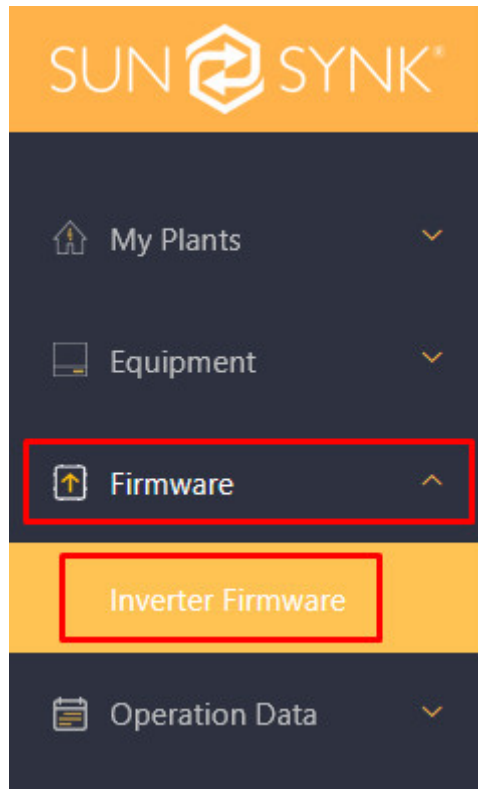

Click the 'Publish' button and follow the prompts in the pop-up page to complete the new firmware release operation.

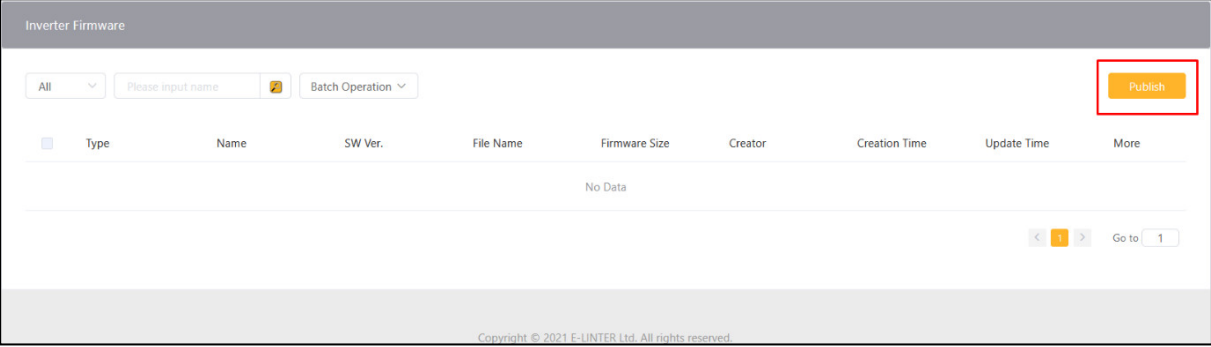

When a certain inverter firmware is no longer in use, Sunsynk can delete the firmware that need to be deleted in the firmware list, click the more '(...)' button, and follow the prompts to complete the 'Delete', as shown in the figure below.

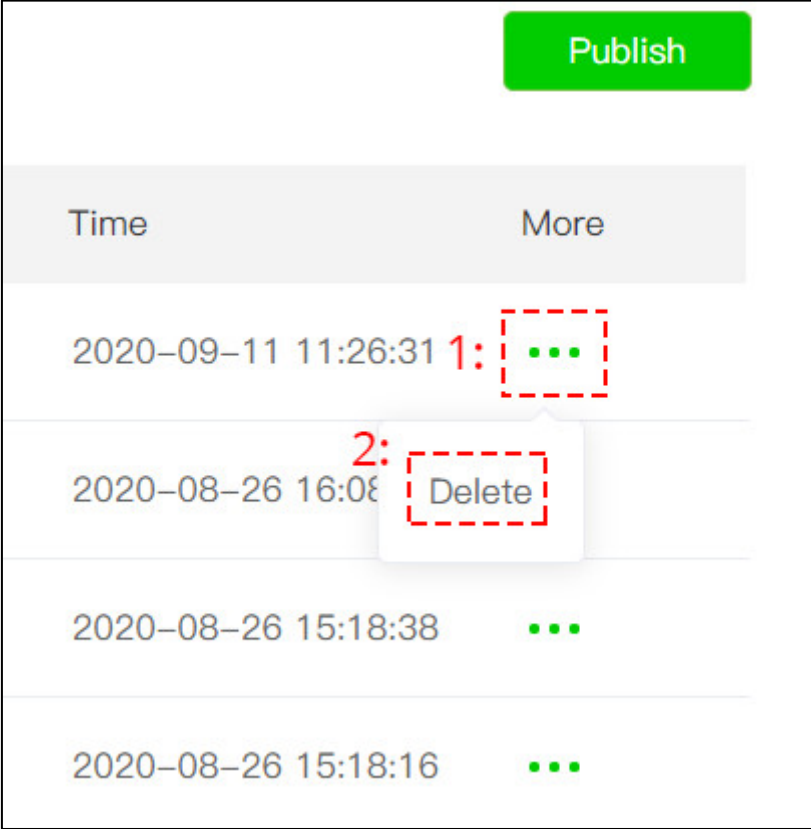

4.6. INVERTER FIRMWARE MANAGEMENT

Click 'Operation Data' in the menu to enter the Operation Date page.

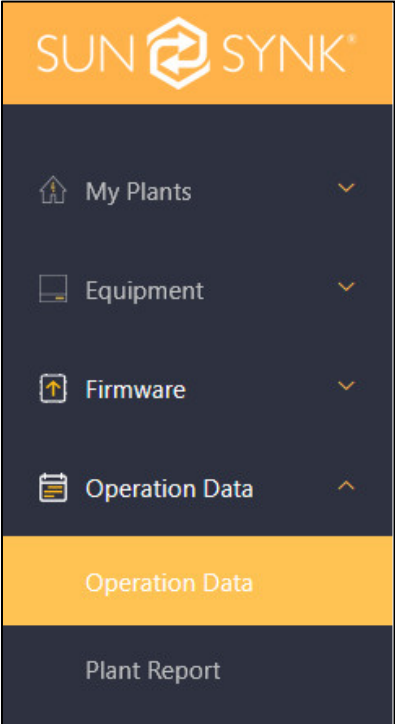

- 1) Enter the inverter's serial number (SN) for which data needs to be viewed.
- 2) Select the date range.
- 3) Click the search button to view the inverter's operational data.

If you need to download the data to your local device, click the 'Download' button to save it as a file in the ".xlsx" format.

The image shows a data table with four columns: Vac1(V), Vac2(V), Vac3(V), and Iac1(A). The table contains four rows of data. A 'Download' button is located in the top right corner of the table area, highlighted with a red dashed box.

Vac1(V)	Vac2(V)	Vac3(V)	Iac1(A)
260.9	0.0	0.0	0.0
260.9	0.0	0.0	0.0
262.6	0.0	0.0	0.0
260.9	0.0	0.0	0.0

5. ENTERPRISE MANAGEMENT

5.1. COMPANY INFORMATION

In the main menu, click 'Company' → 'Info' to enter the Information page, where you can add company information according to the prompts.

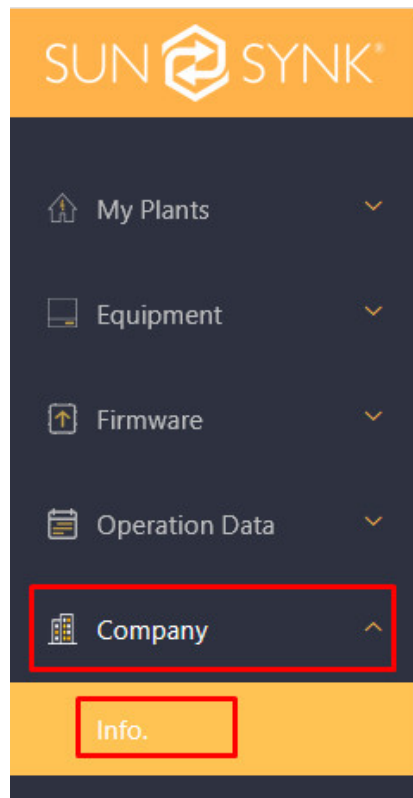

To update/change the company information, click the 'Edit' button on the Information page.

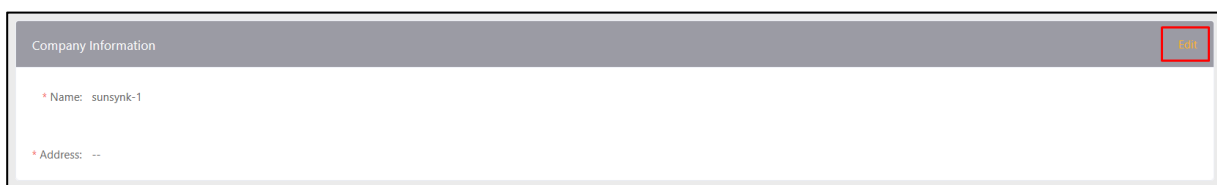
A screenshot of the 'Company Information' page in the SunSynk application. The page has a grey header with the text 'Company Information' and a red 'Edit' button in the top right corner. Below the header, there are two input fields: '* Name: sunsynk-1' and '* Address: --'. The page has a white background with a grey border.

5.2. ROLE MANAGEMENT

In the main menu, click 'Company' → 'Info' to enter the Role page.

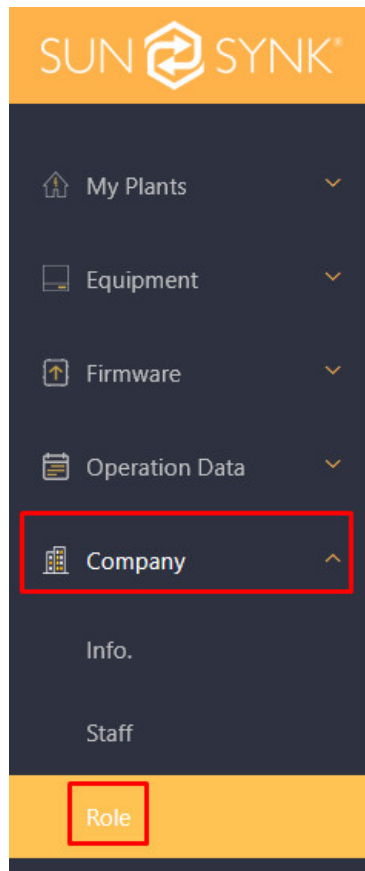

Click the 'Add' button on this page to enter the role name and select the permissions you want to assign in the pop-up window to complete the new role addition. As shown below.

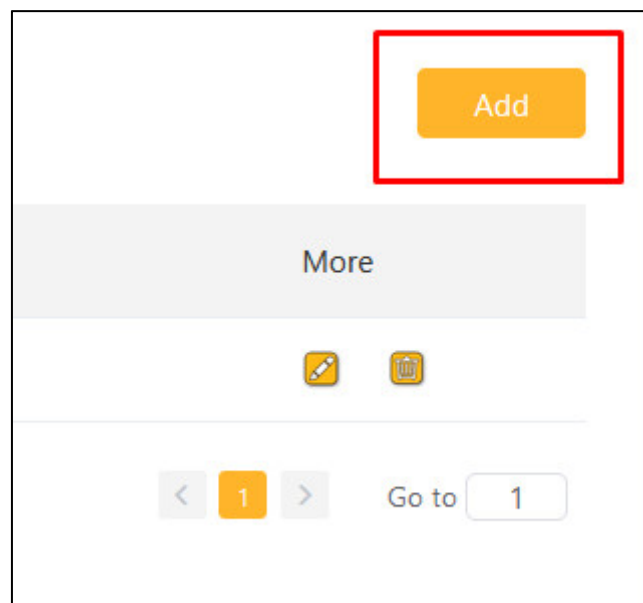

When you need to edit the permissions of a role or delete the role, click the 'Edit' or 'Delete' button behind the role in the 'Role List' to complete the operation. As shown in the figure below.

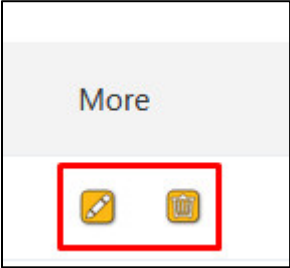

5.3. STAFF MANAGEMENT

In the main menu, click 'Company' → 'Staff' to enter the Staff page.

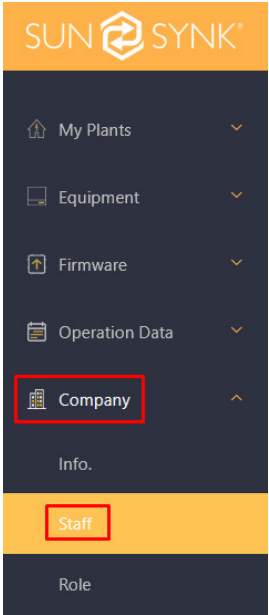

Click the 'Add' button and follow the prompts to complete the addition of new employees. As shown below.

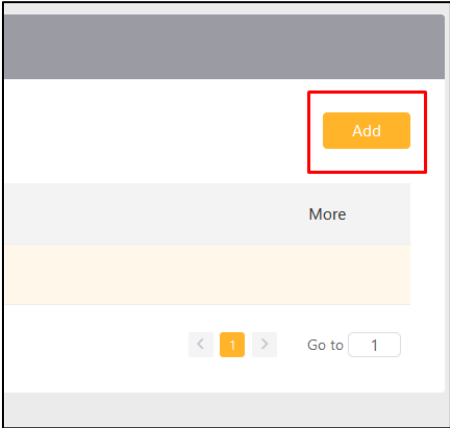

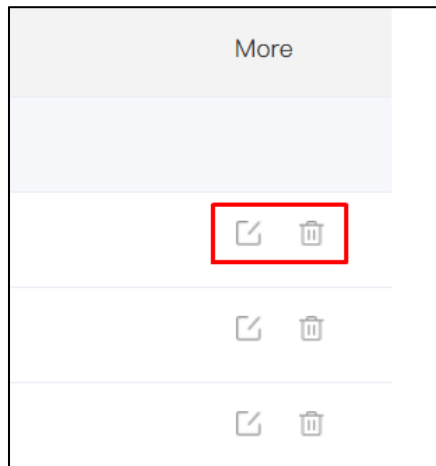

When an employee changes, you can find the employee in the Staff List page and click the 'Edit' or 'Delete' button to change the role of the employee or delete the employee.

5.4. SETTING / CHANGING CUSTOMER PERMISSIONS

If you are an installer, you have the ability to change and set your customers permissions.

5.4.1 Creating user permissions

You need to start by creating a Customer Type.

1) In the menu, first click 'Customer', then 'Customer Type'.

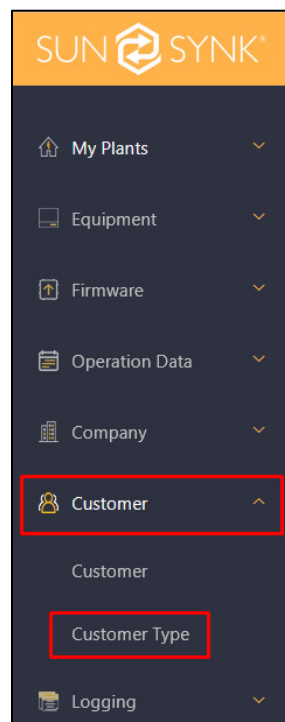

2) Here you then want to click 'Add' to create a customer type.

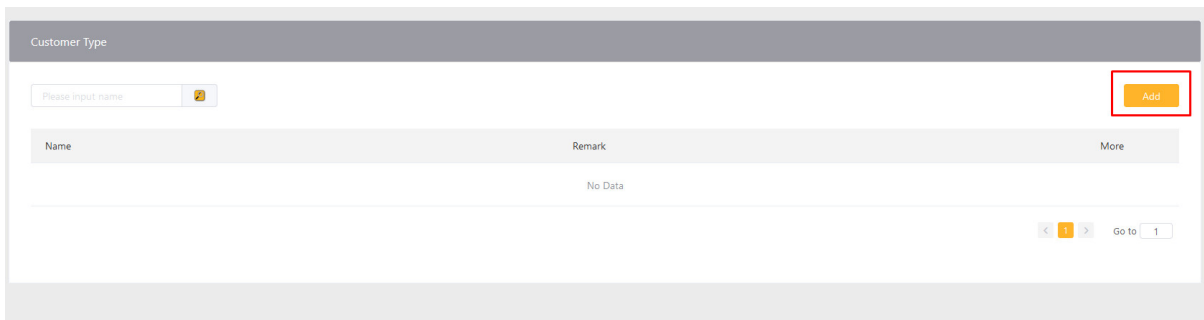

3) You will need to give the customer type a name and remark. For example, we have used 'Advanced Customer' as the name and a brief description of what that customer type has access to in the 'Remark' section. You can then set the appropriate sections that you feel this Customer Type can have access to.

Create Type

5.4.2 Assigning customer permissions

After creating the customer type, you need to assign the customer type you created to your customer.

1) In the main menu, first click 'Customer', the 'Customer'.

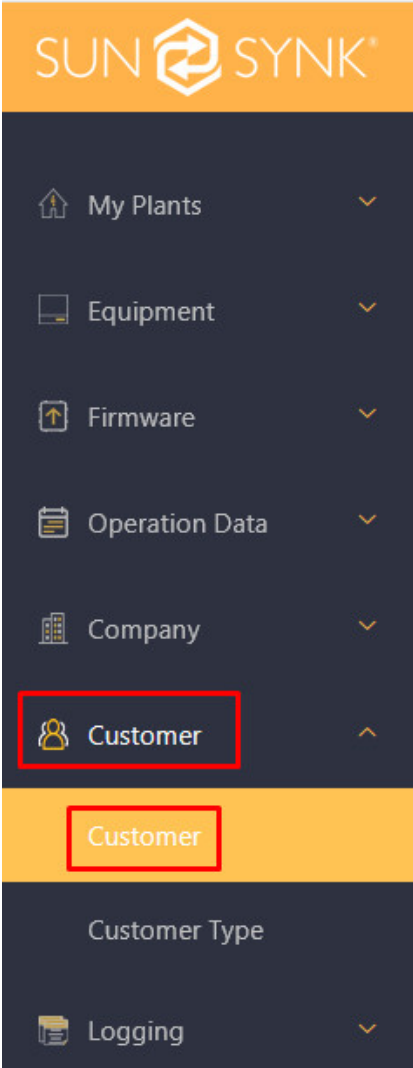

2) Then click 'Add' to the customer and assign the customer type.

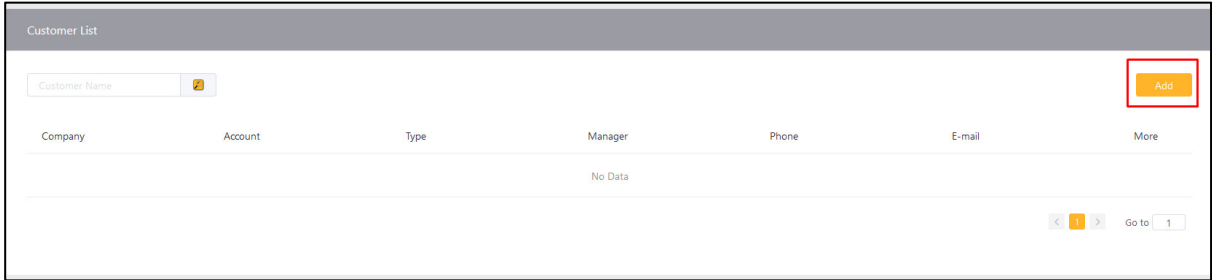

3) You now need to enter the customer username in the 'Account' field, select you 'Customer Type' that you just created from the drop-down list, and then enter the company or users name in the 'Company' field (this is mainly for your records). Finally click 'Confirm' to save the changes.

Add customer

* Account

* Type

* Company

5.5. SHARING A PLANT

If you are an installer and need to share the plant you created for a customer, follow the steps below.

1) In the menu, first click 'My Plant', then 'Plant List'.

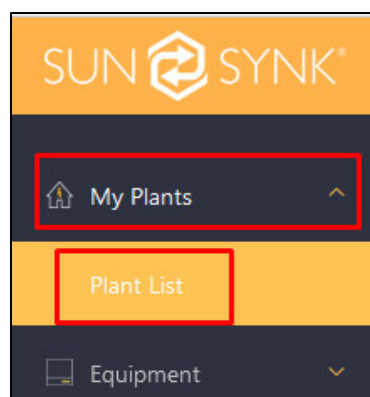

2) Click 'More' (...) and then 'Share' in the plant you want to share.



3) You will then be presented with the option to share to an account. At this moment, you need to enter the customers username that they used to sign up to the platform, and finally click 'Confirm'.

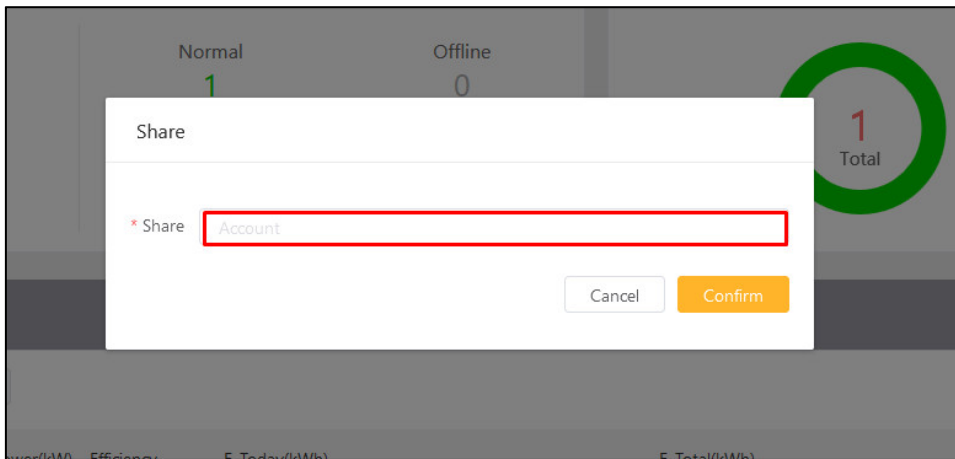

For more information, training videos, software upgrades, help line, forum please refer to <http://www.sunsynk.com> - Tech Support (Do not forget to register first on the website).



Sunsynk



@energysolutions



@sunsynkofficial

Sunsynk Limited & Global Tech China Ltd,
3 Floor, Wai Yip Industrial Building.
171 Wai Yip Street, Kwun Tong,
Kowloon, Hong Kong.
Tel. HK +852 2884 4318 Fax: +852 2884 4816
Tel. UK +44 151 528 9945
Tel. SA +27 1108 39837
sales@globaltech-china.com

Audio Training manuals on Apple Pod Cast and Spotify
Full training support, manuals and videos on www.sunsynk.com



Global Tech China Ltd

3rd Floor, Wai Yip Street Kwun Tong, Kowloon, Hong Kong

Want to become a distributor? Or want to know more?

Email us: sales@globaltech-china.com Our website: www.sunsynk.com

GT website: www.globaltechchina.com

